

# ACCESSORIES COUPLING AND FITTINGS

## Union re-usable coupling



### PRODUCTS' RANGE

Code	Description	Inlet/Outlet			Key 1	Key 2
		A BSP	B mm	C mm		
<b>Swivel</b>						
000890000	Union 34.27	3/4"	19	27	38	38
000891000	Union 1.27	1"	19	27	31	31
000892000	Union 1.35	1"	25	35	38	38
000893000	Union 34.32	3/4"	19	32	31	31
000894000	Union 1.32	1"	19	32	38	38
000895000	Union 1.38	1"	25	38	38	38

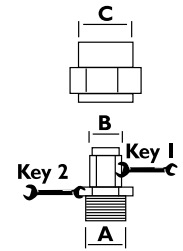

1



2



3



4

## HQC Hose Quick Coupling

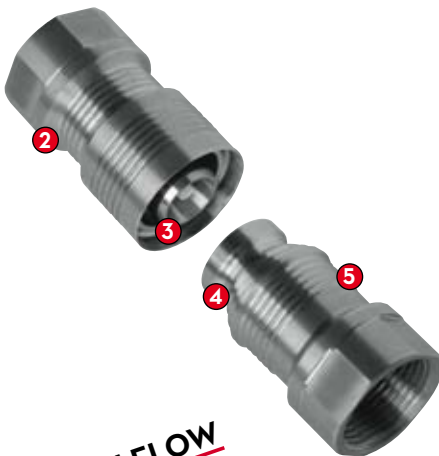
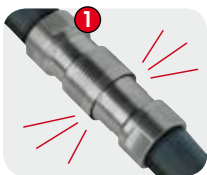

**HIGH FLOW**

**EN.** Hose quick coupling PIUSI has developed a new quick coupling that is suitable for use with diesel. In the past, quick couplings for use with diesel derived from quick couplings that were intended for use with oil, where the bores on the interior were too small for the diesel supply flow. With this quick coupling, this issue does not come into play. Here the bore has been designed to minimise resistance in the presence of high flow rates during the supply of the diesel.

1 - Fully closed position  
2 - Open position  
3 - Male coupling  
4 - Female coupling  
5 - Embossed profile: improves grip for coupling/uncoupling.

**ES.** Conexión rápida para tubo PIUSI ha desarrollado una nueva conexión rápida apta para el uso con gasóleo. En el pasado, las conexiones rápidas para gasóleo derivaban de conexiones rápidas para aceite y los orificios internos no eran lo suficientemente grandes para el caudal del suministro del gasóleo. Hoy, el orificio de esta conexión rápida ha sido diseñado para reducir al mínimo la resistencia en presencia de altos caudales durante el suministro del gasóleo.

1 - Posición todo cerrado  
2 - Posición abierta  
3 - Conexión macho  
4 - Conexión hembra  
5 - Perfil en relieve: mejora el agarre en fase de enganche-desenganche.

**RU.** Быстрое соединение для трубы Компания PIUSI разработала новое быстрое соединение, которое можно использовать с дизельным топливом. Ранее быстрые соединения для дизельного топлива создавались на базе быстрых соединений для масла, внутренний диаметр которых был недостаточно крупным для обеспечения подачи дизельного топлива. В свою очередь, внутренний диаметр этого быстрого соединения разработан с целью свести к минимуму сопротивление при высокой скорости потока дизельного топлива.

1 - Полностью закрытое положение  
2 - Открытое положение  
3 - Входящая часть соединения  
4 - Охватывающая часть соединения  
5 - Выпуклый профиль: улучшает захват при соединении и разъединении.

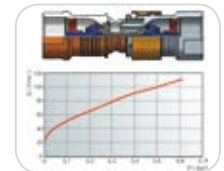

**EN.** Moulded internal profile: reduces pressure loss.

**ES.** Perfil interno conformado: reduce las pérdidas de carga

**RU.** Литой внутренний профиль: снижает потери напора.

### PRODUCTS' RANGE

Code	Description	Weight	Pack.	Packaging
		Kg	pcs. no.	mm
<b>HQC</b>				
F00636000	HQC Hose Quick Coupling 1"	0,46	1	80x80x75

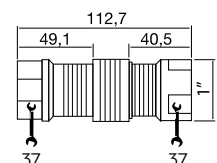

**PRODUCTS' RANGE**
**Elbows**

Code	Description	A	B	Q.ty	Key
<b>Elbows</b>					
F07806000		F 3/4" BSP	F 3/4" BSP	-	-
F07805000		M 3/4" BSP	F 3/4" BSP	-	-
F08609000		F 1" BSP	F 1" BSP	-	-
F07988000		M 1" BSP	F 1" BSP	-	-
F14279000	Inox	M 1" BSP	F 1" BSP	-	-

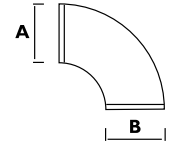

**Hose tails**

Inox Version

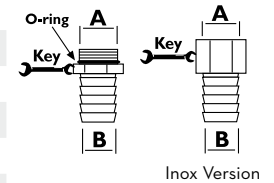
<b>Hose tails</b>					
F0826700A		1/2" BSP	19 mm	1	24
F0643700A		3/4" BSP	19 mm	20	32
F0776800B		3/4" BSP	25 mm	20	32
F0775700A		1" BSP	19 mm	20	37
F0776400A		1" BSP	25 mm	20	37
F14122000	Inox	M 1" BSP	19 mm	1	37
F14123000	Inox	F 3/4" BSP	19 mm	1	37

**Rotating hose tails - Inox**

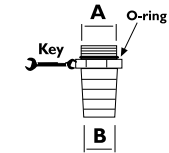

<b>Rotating hose tail - Inox</b>					
F14132000	Inox	3/4" BSP	19 mm	-	27

**Sleeve**

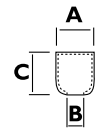

<b>Sleeve</b>					
F08137000		28 mm	20 mm	-	30
F08138000		36 mm	28 mm	-	35

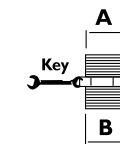
**Sleeve**

<b>Sleeve</b>					
F07766000		M 3/4" BSP	M 3/4" BSP	-	27
F07765000		M 1" BSP	M 1" BSP	-	34

**Reducing sockets**

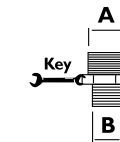
<b>Reducing sockets</b>					
F07441000		F 1/2" BSP	M 3/4" BSP	-	30
F07762000		M 3/4" BSP	M 1" BSP	-	34
F08913000		M 1" BSP	M 1 1/2" BSP	-	50
F07760000		F 3/4" BSP	M 1" BSP	-	35
F07889000		F 1" BSP	M 3/4" BSP	-	34
008891000		F 1" BSP	M 2" BSP	-	60

**Elbow rotating connector**

M/1" BSP

 Code **F14567000**
**Sealant paste**

Code	Description		Q.ty
F08173000	Light removable	g. 130	1
F10767000	Medium removable	ml. 250	1
F12278000	Heavy non removable	ml. 250	1

